



# 160W AC-DC可信赖的绿色医疗型适配器 GSM160B系列



Energy Verified  
Rendement  
Énergétique Vérifié



EN60601-1 ANSI/AAMI ES60601-1 IEC60601-1



## ■ 特性:

- 2极交流IEC320-C8输入接口, Class II 电源
- 通过ANSI/AAMI ES60601-1和IEC/EN60601-1 医疗类安规认证(2 x MOPP)
- 极低漏电流
- 空载功耗<0.15W
- 能效等级 VI 并满足CoC Version 5
- -30~+70°C 宽工作温度范围
- 保护种类: 短路/过负载/过电压/过温度
- LED指示电源开启
- 寿命>110K小时
- 3年保固

## ■ 应用:

- 移动临床工作站
- 冲牙器
- 便携式血液透析仪
- 呼吸机
- 医疗电脑监视器

## ■ 描述:

GSM160B系列是一个高信赖性, 160W桌上型单组输出绿色环保医疗型适配器, 该产品装配 IEC320-C8 AC 标准插头。采用80Vac~264Vac输入电压, 整系列提供从12Vdc到48Vdc之间不同的输出电压, 能够满足各种医疗电气设备的需求。电路设计符合国际医疗标准(2 \* MOPP), 具有超低漏电流(<100µA), 适合用于与患者直接接触的医疗设备。

GSM160B效率高达94%, 低于0.15W的超低空载功耗, GSM160B符合USA EISA 2007/DoE, Canada NRCAN, Australia and New Zealand MEPS, EU ErP, 并且满足Code of Conduct (CoC) Version 5;最显著的特征是当工作于正常模式或待机模式时, 适配器可节省能耗。整系列采用94V-0阻燃塑料外壳, 提供能有效防护电击的双重绝缘保护。GSM160B通过国际医疗安全认证。

## ■ 型号编码

**GSM160B 12 - R7B**

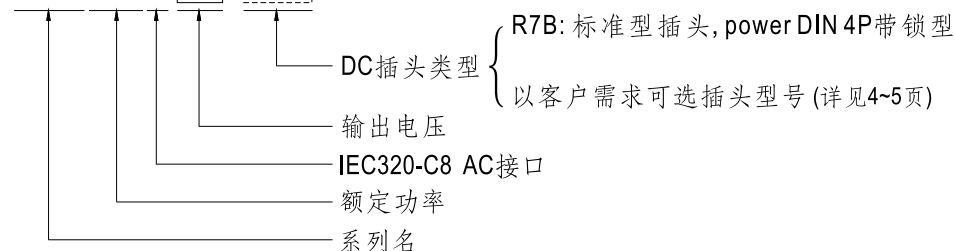



# 160W AC-DC可信赖的绿色医疗型适配器 GSM160B系列

## 电气规格

型号		GSM160B12-R7B	GSM160B15-R7B	GSM160B20-R7B	GSM160B24-R7B	GSM160B48-R7B	
输出	安规型号	GSM160B12	GSM160B15	GSM160B20	GSM160B24	GSM160B48	
	直流电压 备注2	12V	15V	20V	24V	48V	
	额定电流	11.5A	9.6A	8A	6.67A	3.34A	
	电流范围	0~11.5A	0~9.6A	0~8A	0~6.67A	0~3.34A	
	额定功率(最大)	138W	144W	160W	160W	160W	
	纹波与噪声(最大)备注3	80mVp-p	100mVp-p	120mVp-p	120mVp-p	150mVp-p	
	电压精度 备注4	±5.0%	±5.0%	±4.0%	±3.0%	±3.0%	
	线性调整率 备注5	±1.0%	±1.0%	±1.0%	±1.0%	±1.0%	
	负载调整率	±5.0%	±5.0%	±4.0%	±3.0%	±3.0%	
	启动,上升时间 备注6	2000ms, 50ms / 230VAC      2500ms, 50ms / 115VAC(满载时)					
	保持时间(Typ.)	24ms / 230VAC      24ms / 115VAC(满载时)					
输入	电压范围 备注7	80~264VAC    113~370VDC					
	频率范围	47~63Hz					
	功率因数(Typ.)	12V/15V:PF>0.93 / 230VAC		20V,24V,48V:PF>0.94 / 230VAC		PF>0.98 / 115VAC(满载时)	
	效率(Typ.)	90%	91%	92.5%	93.5%	94%	
	交流电流(Typ.)	1.85A / 115VAC    1A / 230VAC					
	浪涌电流(Typ.)	冷启动: 90A / 115VAC    110A / 230VAC					
	漏电流(最大)	接触电流< 100μA/264VAC					
保护	过负载	额定输出功率的105%~150% 保护模式:打嗝模式, 负载异常条件移除后可自动恢复					
	过电压	额定输出电压的105%~135% 保护模式:关断输出电压, 重启恢复					
	过温度	关断输出电压, 重启恢复					
环境	工作温度	-30~+70°C (请参考"减额曲线")					
	工作湿度	20~90% RH,无冷凝					
	储存温度、湿度	-40~+85°C, 10~95% RH,无冷凝					
	温度系数	±0.03%/°C (0~40°C)					
	耐振动	10~500Hz, 2G 10分钟/周期, X、Y、Z轴各60分钟					
	操作高度 备注8	3000米					
安规和 电磁兼容 (备注9)	安全规范	IEC60601-1, EN60601-1/EN60601-1-11, ANSI/AAMI ES60601-1/ES60601-1-11(3.1 version), CAN/CSA-C22.2 No. 60601-1:14 - Edition 3,EAC TP TC 004认证通过					
	绝缘防护等级	一次侧-二次侧: 2xMOPP					
	耐压	I/P-O/P:4KVAC					
	绝缘阻抗	I/P-O/P:100M Ohms / 500VDC / 25°C / 70% RH					
	电磁兼容发射	<b>Parameter</b>	<b>Standard</b>		<b>Test Level / Note</b>		
		Conducted emission	EN55011 (CISPR11), FCC PART 15 / CISPR22, CAN ICES-3(B)/NMB-3(B)		Class B		
		Radiated emission	EN55011 (CISPR11), FCC PART 15 / CISPR22, CAN ICES-3(B)/NMB-3(B)		Class B		
		Harmonic current Voltage flicker	EN61000-3-2 EN61000-3-3		Class A -----		
	电磁兼容抗扰度	EN55024, EN60601-1-2, EN61204-3					
		<b>Parameter</b>	<b>Standard</b>		<b>Test Level / Note</b>		
		ESD	EN61000-4-2		Level 4, 15KV air ; Level 4, 8KV contact		
		RF field susceptibility	EN61000-4-3		Level 3, 10V/m( 80MHz~2.7GHz ) Table 9, 9~28V/m( 385MHz~5.78GHz )		
		EFT bursts	EN61000-4-4		Level 3, 2KV		
		Surge susceptibility	EN61000-4-5		Level 3, 1KV/Line-Line		
Conducted susceptibility		EN61000-4-6		Level 3, 10V			
Magnetic field immunity		EN61000-4-8		Level 4, 30A/m			
Voltage dip, interruption	EN61000-4-11		100% dip 1 periods, 30% dip 25 periods, 100% interruptions 250 periods				
其它	MTBF	239.1K hrs min. MIL-HDBK-217F(25°C)					
	尺寸	175*72*35mm (L*W*H)					
	包装	0.66Kg; 20pcs/14.2Kg/1.06CUFT					
连接器	插头	参考第4~5页,其它型号可依客户需求订制					
	配线	参考第4~5页,其它型号可依客户需求订制					
备注	1. 如未特别说明, 所有规格参数均在输入为230VAC、额定负载、25°C 70%RH 环境温度下进行量测。 2. 直流电压测量方法:在50%负载条件下,在插座端子点量测。 3. 纹波和噪声测量方法: 使用一条12"双绞线, 同时终端要并联0.1uf和47uf的电容, 在20MHZ带宽下进行量测。 4. 精度: 包含设定误差、线性调整率和负载调整率。 5. 线性调整率测量方法: 在额定负载下,从低电压到高电压测试。 6. 启动时间是在冷机启动下测得, 频繁的开关机可能使启动时间增长。 7. 低输入电压情况下需减额输出, 具体请参考静态特性曲线图。 8. 当海拔高度超过2000米(6500英尺)时, 无风扇机型环境温度依每3.5°C/1000m比例下降, 有风扇机型环境温度依每5°C/1000m比例下降。 9. 电源被视为系统内元件的一部分, 需结合终端设备进行电磁兼容相关确认。 EMC测试方法的指引, 请参照明纬公司网站 <a href="http://www.meanwell.com.cn">http://www.meanwell.com.cn</a> 上的“EMI测试声明书”。						

### ■ 减额曲线

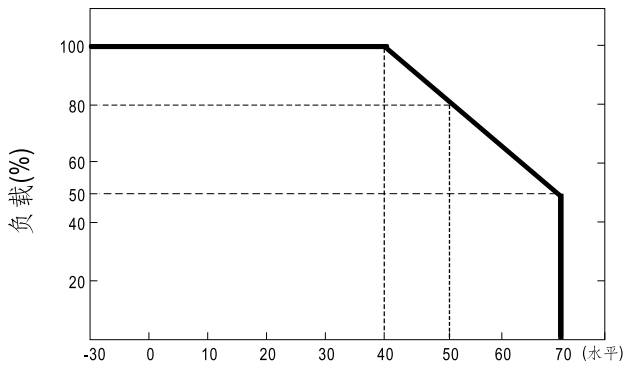

环境温度 (°C)

### ■ 静态特性曲线

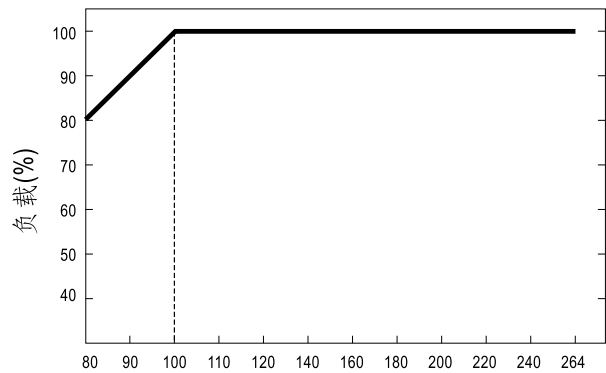

输入电压(VAC) 60Hz

### ■ 机构尺寸

机壳型号: GS160A 单位:mm

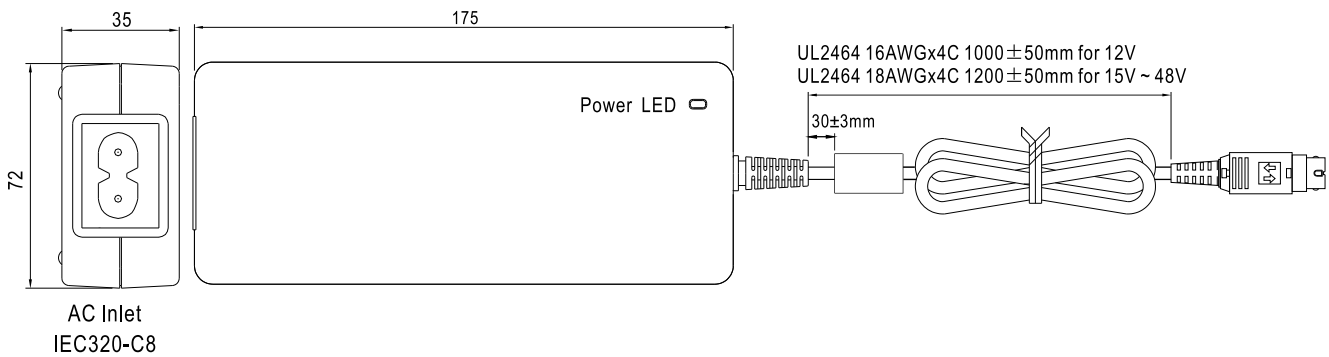





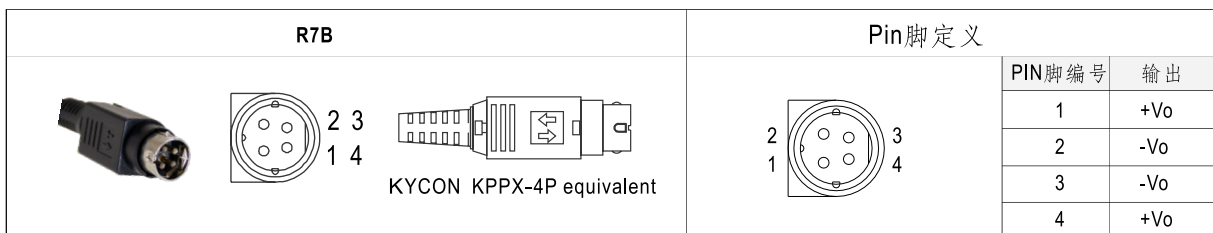



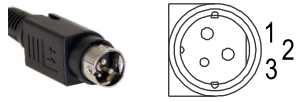
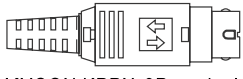

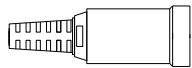
### ■ DC输出插头

◎ 标准插头: R7B

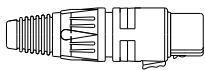

◎ 可选DC插头:

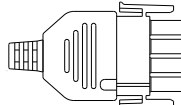
Min. DIN 3 Pin with Lock (公头)	型号	Pin脚定义	
		PIN脚编号	输出
  KYCON KPPX-3P equivalent	R6B	1	+Vo
		2	-Vo
		3	+Vo
Min. DIN 4 Pin with Lock (母头)	型号	Pin脚定义	
		PIN脚编号	输出
  KYCON KPJX-CM-4S equivalent	R7BF	1	+Vo
		2	-Vo
		3	-Vo
		4	+Vo
DIN 5 Pin (公头)	型号	Pin脚定义	
		PIN脚编号	输出
 	R1B	1	-Vo
		2	-Vo
		3	+Vo
		4	-Vo
		5	+Vo
NEUTRIK XLR NC4FX equivalent	型号	Pin脚定义	
		PIN脚编号	输出
 	MIC4	1	+Vo
		2	+Vo
		3	-Vo
		4	-Vo
MOLEX 39-01-2060 (4.2mm) equivalent	型号	Pin脚定义	
		PIN脚编号	输出
  FG未连接到输出连接器	C6P	1	+Vo
		2	+Vo
		3	+Vo
		4	-Vo
		5	-Vo
		6	-Vo
AMP 1-480702-0 (6.35mm) equivalent	型号	Pin脚定义	
		PIN脚编号	输出
  FG未连接到输出连接器	C4P	1	+Vo
		2	+Vo
		3	-Vo
		4	-Vo



# 160W AC-DC可信赖的绿色医疗型适配器 **GSM160B**系列

剥线和镀锡引线	型号	Pin脚定义	
		PIN脚编号	输出
<p>L1的长度可根据需求订制 (明纬标准品长度, L: <u>25</u> mm, L1: <u>5</u> mm)</p>	订制品	1	+Vo
		2	-Vo

## ■ 安装手册

请查阅：<http://www.meanwell.com/manual.html>